

Combi Modular System

Standardised centrifugal pumps



EN 733

ISO 2858

ISO 5199

API 610



SPX FLOW Johnson Pump brand water, chemical and petrochemical standardised pumps represent a range of centrifugal pumps designed and manufactured in our plants in accordance with EN 733 (DIN 24255), ISO 5199 & ISO 2858 (EN 22858 / DIN 24256) or API 610.

A characteristic of our standardised pumps is the large number of material, shaft seal and bearing system options available. This allows us to offer a pump nearly tailor-made for your application using standard components.

Our modular design provides for maximum interchangeability of components between the variants and also with other pump types of the Combi system; thereby greatly limiting the number of spare parts to be kept in stock.

Our CE and ATEX certified pumps can be delivered from our plants as single pumps, pump units with motors, baseplate-mounted pump units and OEM units.

Based in Charlotte, North Carolina, SPX FLOW, Inc. (NYSE: SPW) is a global, multi-industry manufacturing leader with operations in more than 35 countries. The company's highly-specialized, engineered products and technologies are concentrated in Flow Technology and energy infrastructure. Many of SPX FLOW's innovative solutions are playing a role in helping to meet rising global demand for electricity and processed foods and beverages, particularly in emerging markets.

The company's products include food processing systems for the food and beverage industry, critical Flow components for oil and gas processing, power transformers for utility companies, and cooling systems for power plants. For more information, please visit www.spxflow.com

EN 733

(DIN 24255)

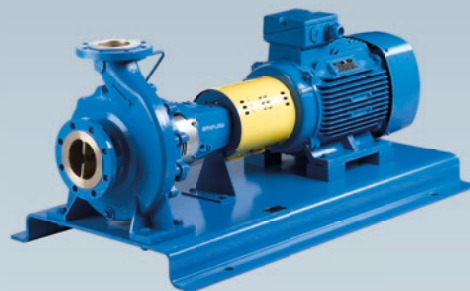

TECHNICAL DATA

Max. capacity:	1500 m ³ /h
Max. head:	100 m
Max. system pressure:	10 bar
Max. temp.:	200°C
Max. speed:	3600 rpm

MATERIALS

	PUMP CASING	PUMP COVER	IMPELLER	SHAFT	SHAFT SLEEVE
CAST IRON	X	X	X	-	-
NODULAR CAST IRON	X	X	-	-	-
BRONZE	X	X	X	-	-
STAINLESS STEEL	-	-	X	X	X
ALLOY	-	-	-	X	X

SPX FLOW Johnson Pump brand water standardised pump represents a range of horizontal centrifugal pumps ideal as utility or general purpose pumps. The pump is designed to EN 733 (DIN 24255); however, it has a wider hydraulic field due to a larger number of available sizes.

Flange dimensions, bolt circle and number of holes comply with ISO 7005 PN 10 / PN 16 (ISO 7005 ≈ EN 1092-2 (DIN 2533)).

The pump is driven by a standard IEC foot motor. The power is transmitted through a standard or spacer coupling.

Handles all types of low viscosity, clean or slightly contaminated liquids.

Application fields

- Industry as a general purpose pump
- Utility as a general duty, circulation or water treatment pump
- Agriculture and Horticulture as irrigation and circulation heating pumps

ISO 5199

ISO 2858

(EN22858 / DIN24256)



TECHNICAL DATA

Max. capacity:	800 m ³ /h
Max. head:	160 m
Max. system pressure:	16 bar
Max. temp.:	200°C
Max. speed:	3600 rpm

MATERIALS

	PUMP CASING	PUMP COVER	IMPELLER	SHAFT	SHAFT SLEEVE
CAST IRON	X	X	X	-	-
NODULAR CAST IRON	X	X	-	-	-
BRONZE	X	X	X	-	X
STAINLESS STEEL	X	X	X	X	X
ALLOY	-	-	-	X	X

SPX FLOW Johnson Pump brand chemical standardised pump complies entirely to ISO 5199, which comprises important technical guidelines for “Chemical pumps” to ensure optimal reliability.

The pump represents a range of horizontal centrifugal pumps, designed to ISO 2858 (EN22858 / DIN24256) for heavy duty applications as a process pump in the chemical industry.

Flange dimensions, bolt circle and number of holes comply with ISO 7005 PN 16. The pumps are also available with flanges according to ANSI B16.5-150 lbs (ISO 7005 PN20).

The pump is driven by a standard IEC foot motor. The power is transmitted through a standard or spacer coupling; also available with magnetic coupling in long or close-coupled design.

Handles all types of low viscosity, clean or slightly contaminated liquids.

Application fields

- Chemical industry as an ISO 5199 compliant pump
- Industry as a heavy duty general purpose pump

API 610

ISO 13709



TECHNICAL DATA

Max. capacity:	350 m ³ /h
Max. head:	160 m
Max. system pressure:	35 bar
Operating temp. range:	-30°C – +350°C
Max. viscosity:	300 mm ² /s
Max. speed:	3600 rpm

MATERIALS

COMBINATIONS API 610 CODE S-1, S-6, S-8, C-6, A-8

	PUMP CASING	PUMP COVER	IMPELLER	SHAFT	BEARING BRACKET
CAST IRON	-	-	X	-	-
NODULAR CAST IRON	-	-	-	-	X
CARBON STEEL	X	X	-	-	X
13% CR-STEEL	X	X	X	-	-
STAINLESS STEEL (316)	X	X	X	X	-
ALLOY STEEL	-	-	-	X	-

other materials upon request

SPX FLOW Johnson Pump brand petrochemical standardised pump represent a range of horizontal centerline supported centrifugal pumps, designed to API 610 OH2 standards and to API 682 seal standards for heavy duty applications as a process pump in the petrochemical industry.

The construction easily meets the requirements laid down in American Petroleum Institute standard “Centrifugal Pumps For General Refinery Service”, API 610.

Flange dimensions, bolt circle and number of holes comply with ISO 7005 PN 50 or PN 20 (ANSI B16.5 300lbs– 150lbs).

Fully integrated design of pump, IEC motor, API 610 compliant baseplate and accessories. Also available in vertical in-line API 610 OH3 design.

Handles all types of low viscosity, clean or slightly contaminated liquids.

Application fields

- (Petro)Chemical industry and refineries as an API 610 compliant pump
- Industry as a heavy duty general purpose pump

Combi Modular System

The Combi system is a modular programme of single stage centrifugal pumps with a high degree of interchangeability of parts between the different pump constructions.

The Combi pumps cover an extensive series of centrifugal pumps which can be supplied as horizontal, vertical and submerged pumps. A number of standards were taken into account in the designing of this pump series; EN 733 (DIN 24255), ISO 2858 (EN 22858 / DIN 24256), ISO 5199 and API 610.

COMPONENT MODULES

The Combi system design can be subdivided into a number of modules:

- bearing unit
- shaft seal
- shaft diameter
- nominal impeller diameter
- hydraulics (impeller/volute combination)

ALWAYS THE RIGHT PUMP

The modular design makes it possible to construct many design variants and it also provides a large degree of interchangeability of components between various pump types and even between the different pump families. This, together with the wide range of materials available, makes it easy to supply the correct design for each specific application; allowing customers to be served in an optimal way.

SPARE PARTS AND MAINTENANCE

The high interchangeability in spare parts between different sizes and even pump families greatly limits spare parts stock levels.

Maintenance is simple in all the Combi models thanks to the use of standard components and the Back-Pull-Out principle.

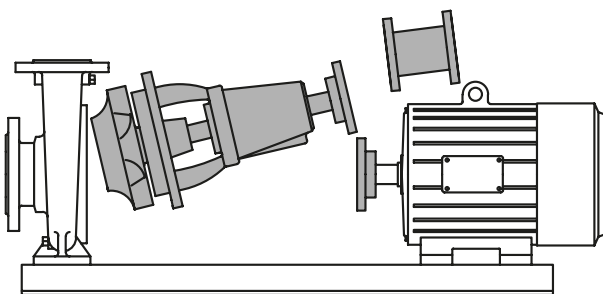

Service friendly with Back-Pull-Out

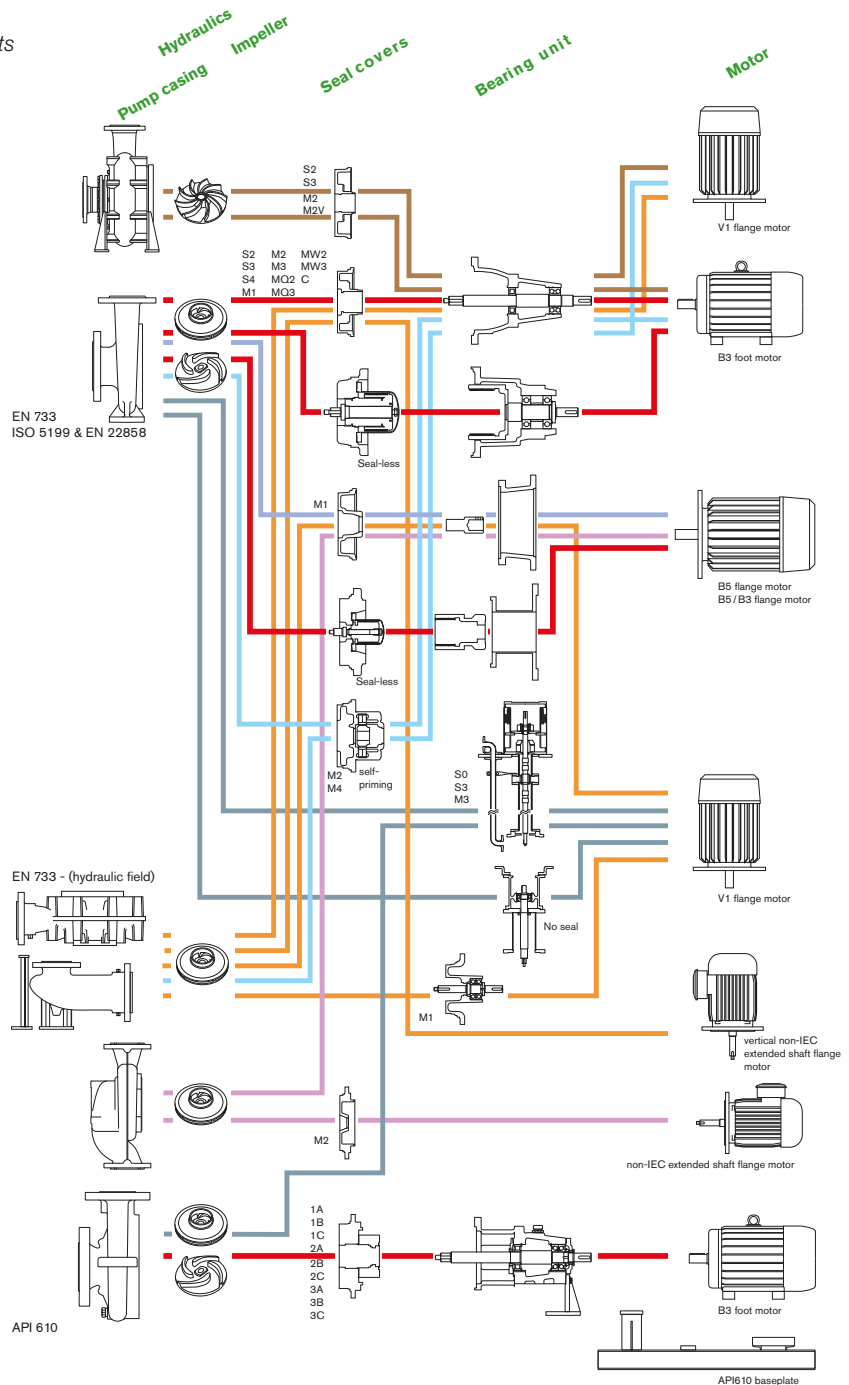

- Solids & gaseous content
- Standardised pumps
- Compact monobloc
- Self-priming
- Submerged with dry motor
- Vertical
- InLine

Shaft sealing

- S0 Oil seal
- S2 Soft packing, shaft sleeve
- S3 Soft packing, shaft sleeve, lantern ring
- S4 Soft packing, shaft sleeve, cooling jacket
- M1 Mechanical seal, unbalanced
- M2 Mechanical seal, unbalanced, shaft sleeve
- M2V Mechanical seal, unbalanced, shaft sleeve, oil quench, integrated venturi system
- M3 Mechanical seal, balanced, shaft sleeve
- M4 Lip seals, shaft sleeve
- MQ2 Mechanical seal, unbalanced, dry-run protection/pressure-less quench, shaft sleeve
- MQ3 Mechanical seal, balanced, dry-run protection/pressure-less quench, shaft sleeve
- MW2 Mechanical seal, unbalanced, heating/cooling jacket, shaft sleeve
- MW3 Mechanical seal, balanced, heating/cooling jacket, shaft sleeve
- C Cartridge seal assemblies
- Seal-less
- Magnetic drive

Mechanical shaft seals according to API 682

- 1A Single seal arrangement 1 type A, pusher type seal
- 1B Single seal arrangement 1 type B, metal bellows rotating flexible element
- 1C Single seal arrangement 1 type C, metal bellows stationary flexible element
- 2A Arrangement 2 Dual seal with unpressurized buffer lower than product type A, pusher type seal
- 2B Arrangement 2 Dual seal with unpressurized buffer lower than product type B, metal bellows rotating flexible element
- 2C Arrangement 2 Dual seal with unpressurized buffer lower than product type C, metal bellows stationary flexible element
- 3A Arrangement 3 Dual seal with pressurized buffer higher than product type A, pusher type seal
- 3B Arrangement 3 Dual seal with pressurized buffer higher than product type B, metal bellows rotating flexible element
- 3C Arrangement 3 Dual seal with pressurized buffer lower than product type C, metal bellows stationary flexible element

Shaft sealing

STUFFING BOX PACKINGS – STANDARD TYPE

S2

Soft packing ring, shaft sleeve

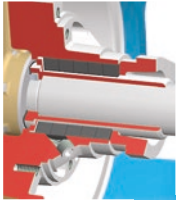

S3

Soft packing ring, shaft sleeve, lantern ring

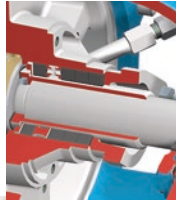

S4

Soft packing ring, shaft sleeve, cooling jacket

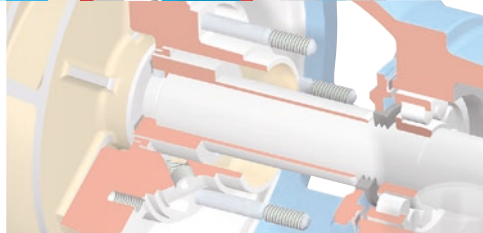
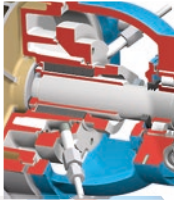

The standardised Combi pumps offer a wide range of shaft sealing options in a variety of materials from **stuffing box packings** to **mechanical seals** to **seal-less** solutions, guaranteeing the optimum shaft sealing for your application.

Thanks to the Combi modular system the built-in geometry is fixed for each shaft diameter. This means that all shaft seal variants can be built into the same space in the pump cover.

In addition, cartridge seals may be fitted to facilitate the replacement of a complete shaft seal set. In particular the API610 standardised pumps are designed to accommodate all common API682 compliant cartridge seals.

MECHANICAL SEALS – ACCORDING TO EN 12756 (DIN24960)

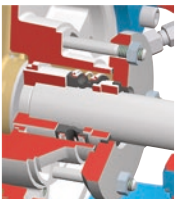

M1

Single mechanical seal, unbalanced



M2 MG12 / M7N

Single mechanical seal, unbalanced, shaft sleeve

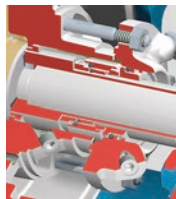

M3 HJ92N / HJ977GN

Single mechanical seal, balanced, shaft sleeve

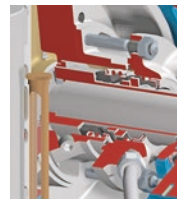

MQ2 MG12 / M7N

Single mechanical seal, unbalanced, dry-running protection or pressure-less quench, shaft sleeve



MQ3 HJ92N / HJ977GN

Single mechanical seal, balanced, dry-running protection or pressure-less quench, shaft sleeve

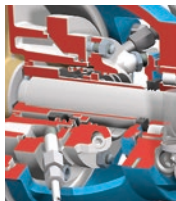

MW2 MG12 / M7N

Single mechanical seal, unbalanced, cooling/heating jacket, shaft sleeve



MW3 HJ92N / HJ977GN

Single mechanical seal, balanced, cooling/heating jacket, shaft sleeve

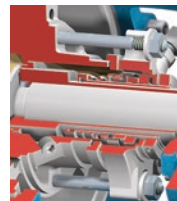

Cartridge seals

single, single with quench and double seals

MECHANICAL SEALS – ACCORDING TO API 682

The seal chamber of our API610 standardised pumps is designed to fit all types of seals, especially API682 cartridge seals.

SEAL-LESS

Ideal for the clean, safe and economical pumping of hazardous or expensive liquids. Handles all types of low viscosity, clean or slightly contaminated non-magnetic and aggressive liquids.

The seal-less options are available in two versions; as a frame-mounted, long coupled magnetic drive and as a space-saving, close-coupled magnetic drive.

Easily retrofitted to existing Combi standardised pumps. Johnson Pump seal-less solutions for the Combi series are easy to maintain and are ATEX certified.

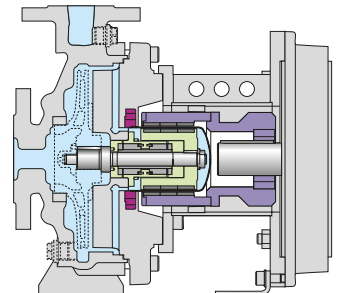
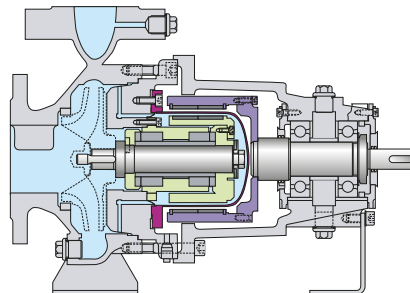

FRAME MOUNTED LONG-COUPLED MAGNETIC DRIVE

Max. capacity	550 m ³ /h
Max head	160 m
Max pressure	16 bar (25 bar optional)
Max temperature	300°C (350°C optional)
Max viscosity	150 mPas
Max power	99 kW at 3000 rpm
Max torque	315 Nm

CLOSE-COUPLED MAGNETIC DRIVE

Max. capacity	280 m ³ /h
Max head	140 m
Max pressure	16 bar (25 bar optional)
Max temperature	200°C
Max viscosity	150 mPas
Max power	45 kW at 3000 rpm
Max torque	168 Nm

Configuration options

In addition to the standardised horizontal end-suction centrifugal pumps the Combi family offers a number of configurations to suit nearly every application need.

THERMAL OIL / HOT WATER DESIGN

- Thermal oil applications up to 350°C
- Hot water applications up to 190°C
- Seals and bearings placed at a distance away from the heating liquid
- Requires no external cooling of the seal faces

IN-LINE PUMP CASING DESIGN

- Built-in circulation pumps with dry motor in a monobloc design
- The pumps can also be installed vertically on a foundation

COMPACT MONOBLOC DESIGN

- Space-saving
- Stub shaft and lantern piece assembly
- EC standard flanged motor

- Specially shaped suction bends ensure low-noise operation and optimum NPSH
- Impeller mounted directly on extended motor shaft or mounted on stub shaft with standard IEC electric motor

VERTICAL CONFIGURATION

- Space-saving
- Combi monobloc designs need only a V1 electric motor for vertical installation
- Other casing options provide for a base with or without an NPSH optimized, variable position suction bend
- Vertical Universal executed with seal options and bearing construction from the standardized chemical pump

SELF-PRIMING

- Combination shaft seal and vacuum pump of liquid ring type
- Shaft seal with integrated venturi/injector system
- Frame mounted IEC motors in horizontal or vertical configurations

SAFE AND LEAK-PROOF DESIGN

- Total containment
- Easy upgrade of mechanical seal pumps to hermetically sealed
- Easy drive-end maintenance while system remains contained
- Frame mounted long coupled design or close coupled design

SUBMERGED PUMP WITH DRY MOTOR

- Combi series of vertical, long-shafted sump pumps
- Standard closed impellers. Half open impellers on request, depending on pump size selection and solids content
- Specially developed range for applications in paint spraying installations with water curtains and cleaning installations with solvents



Black on white with SPX FLOW Johnson Pump



MATERIAL TRACEABILITY EN 10204 CERTIFICATES

- 2.1
- 2.2
- 3.1

SPX FLOW supplies you with a full range of documentation for our centrifugal pumps; everything from material traceability of the components, through quality assurance at our production plants to testing in-house of the final products.

Naturally, our pumps are CE safety certified as well as ATEX explosion protection certified.

SPX FLOW can also supply you with CAD dimensional drawings of our pumps to aid in your planning process.



ISO 9001 CERTIFICATES for our production plants

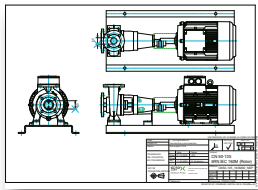

CAD DIMENSIONAL DRAWINGS

for fitting into customer's pipe workings



SAFETY STANDARDS

EC declaration of conformity



EXPLOSION PROTECTION

All of SPX FLOW Johnson Pump Combi centrifugal pumps can be ATEX certified when delivered in assembly with an ATEX certified electric motor.



QHP TESTS ACCORDING TO ISO 9906

VIBRATION TESTS ACCORDING TO ISO 10816-7

NOISE LEVEL TESTS

Combi Modular System

SPXFLOW

Standardised centrifugal pumps

Your local contact:

www.spxflow.com/en/johnson-pump/where-to-buy/

SPX FLOW TECHNOLOGY ASSEN B.V.

Dr. A.F. Philipsweg 51, 9403 AD Assen

P.O. Box 9, 9400 AA Assen, THE NETHERLANDS

P: +31 (0)592 37 67 67

F: +31 (0)592 37 67 60

E: johnson-pump.nl.support@spxflow.com

SPX FLOW reserves the right to incorporate our latest design and material changes without notice or obligation.

Design features, materials of construction and dimensional data, as described in this bulletin, are provided for your information only and should not be relied upon unless confirmed in writing. Please contact your local sales representative for product availability in your region.

For more information visit www.spxflow.com.

The green " > " and " X " are trademarks of SPX FLOW, Inc.